



SEMI-MASSO CON GRIFFE

CLAMP BLOCK BUCKET

GODET BLOC AVEC GRIFFES



Le benne di classe superiore a V-70 sono prodotte su misura e richiesta.
 Buckets class upper than V-70 are tailor-made on demand.
 Les godets d'une classe supérieure à V-70 sont produits sur mesure et sur demande.

Nota / Note

Specifiche idrauliche a pg. 288 - 293
 Hydraulic specifications at pg. 288 - 293
 Spécifications hydrauliques voir pg. 288 - 293

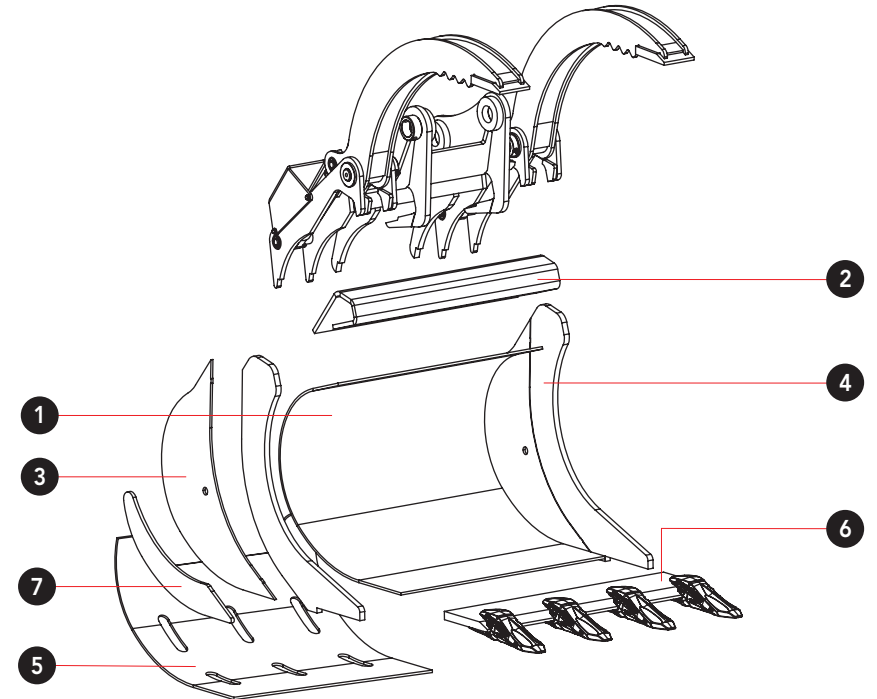

			1	2	3	4	5	6	7
Classe Class Classe	V-55	t 12 15 16	S355 - 10 mm	S355 - 12 mm	S355 - 10 mm	≥HB400 - 20 mm	≥HB400 - 8 mm	≥HB400 - 32 mm	≥HB400 - 10 mm
	V-58	t 15 19 20	S355 - 10 mm	S355 - 18 mm	S355 - 10 mm	≥HB400 - 25 mm	≥HB400 - 10 mm	≥HB400 - 35 mm	≥HB400 - 12 mm
	V-63 / V-64	t 19 26 28	S355 - 12 mm	S355 - 18 mm	S355 - 12 mm	≥HB400 - 30 mm	≥HB400 - 12 mm	≥HB400 - 40 mm	≥HB400 - 15 mm
	V-68 / V-70	t 26 40 42	S355 - 15 mm	S355 - 20 mm	S355 - 12 mm	≥HB400 - 35 mm	≥HB400 - 12 mm	≥HB400 - 50 mm	≥HB400 - 20 mm



SEMI-MASSO CON GRIFFE CLAMP BLOCK BUCKET GODET BLOC AVEC GRIFFES



V-55 t 12 15 16

Code	L mm	RL mm	P mm	n.	ISO 7451 m ³	kg	CAT_STYLE J300	FEURST FK5	MTG MA20	Combi R14	ESCO U30
55 - YGR1	1000	1000	1102	4	0,506	774	-	-	-	-	-
55 - YGRM	1100	1000	1102	5	0,570	805	-	-	-	-	-
55 - YGRN	1200	1000	1102	5	0,632	836	-	-	-	-	-

V-58 t 15 19 20



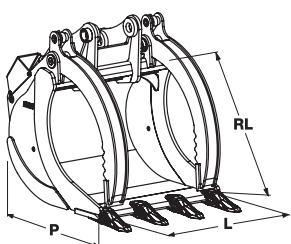



Code	L mm	RL mm	P mm	n.	ISO 7451 m ³	kg	CAT_STYLE J350	FEURST FK5	MTG MA30	Combi R18	ESCO U35
58 - YGR1	1000	1167	1332	4	0,710	999	-	-	-	-	-
58 - YGRM	1100	1167	1332	5	0,800	1061	-	-	-	-	-
58 - YGRN	1200	1167	1332	5	0,890	1103	-	-	-	-	-











SEMI-MASSO CON GRIFFE / CLAMP BLOCK BUCKET / GODET BLOC AVEC GRIFFES







V-63 t 19 23 25

Code	L mm	RL mm	P mm	 n.	ISO 7451 m ³	 kg	 CAT_STYLE J400	 FEURST FK7	 MTG MA40	 Combi R23	 ESCO U40
63 - YGRM	1100	1220	1400	4	0,903	1291	-	-	-	-	-
63 - YGRN	1200	1220	1400	5	1,008	1374	-	-	-	-	-
63 - YGRP	1300	1220	1400	5	1,115	1425	-	-	-	-	-







V-64 t 23 26 28

Code	L mm	RL mm	P mm	 n.	ISO 7451 m ³	 kg	 CAT_STYLE J400	 FEURST FK7	 MTG MA40	 Combi R23	 ESCO U40
64 - YGRM	1100	1300	1520	4	0,948	1330	-	-	-	-	-
64 - YGRN	1200	1300	1520	5	1,060	1414	-	-	-	-	-
64 - YGRP	1300	1300	1520	5	1,172	1467	-	-	-	-	-

V-68 t 26 31 33

Code	L mm	RL mm	P mm	 n.	ISO 7451 m ³	 kg	 CAT_STYLE J460	 FEURST FK9	 MTG MA50	 Combi R29	 ESCO U45
68 - YGRP	1300	1372	1650	5	1,424	2178	-	-	-	-	-
68 - YGRQ	1400	1372	1650	5	1,563	2251	-	-	-	-	-
68 - YGRR	1500	1372	1650	5	1,704	2341	-	-	-	-	-
68 - YGRT	1600	1372	1650	5	1,844	2419	-	-	-	-	-

V-70 t 31 34

Code	L mm	RL mm	P mm	 n.	ISO 7451 m ³	 kg	 CAT_STYLE J550	 FEURST FK9	 MTG MA50	 Combi R29	 ESCO U55
70 - YGRP	1300	1479	1800	5	1,503	2281	-	-	-	-	-
70 - YGRQ	1400	1479	1800	5	1,653	2359	-	-	-	-	-
70 - YGRR	1500	1479	1800	5	1,803	2450	-	-	-	-	-
70 - YGRT	1600	1479	1800	5	1,954	2531	-	-	-	-	-

