

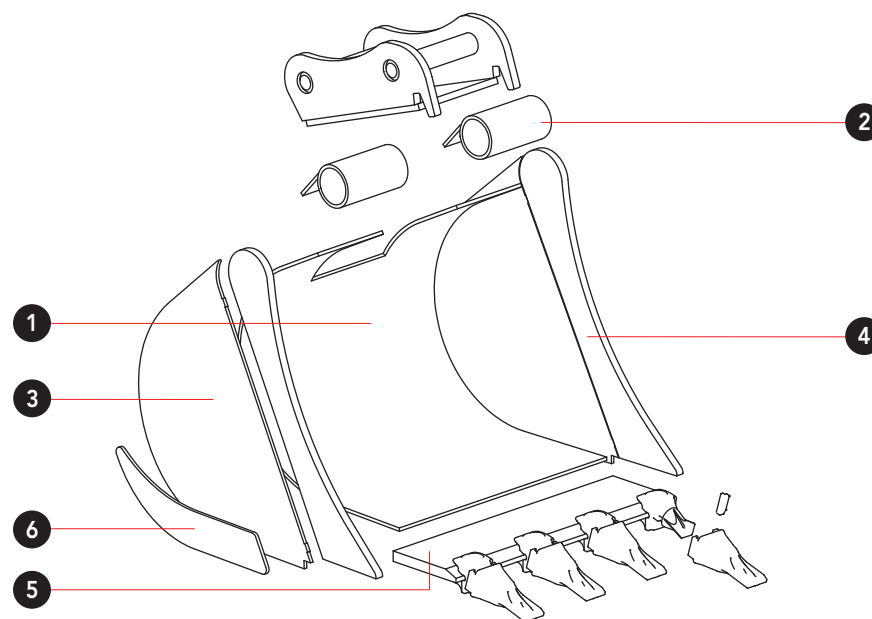

BENNA RINFORZATA MAX LOCK

HEAVY DUTY BUCKET MAX LOCK

GODET RENFORCÉ MAX LOCK









			1	2	3	4	5	6
Classe Class Classe	V-20	t 1,4 - 1,8	≥HB400 - 5 mm	S355 - Ø 60 mm	S355 - 4 mm	≥HB400 - 10 mm	≥HB250 - 15 mm	S355 - 4 mm
	V-25	t 1,8 - 2,5	≥HB400 - 5 mm	S355 - Ø 70 mm	S355 - 4 mm	≥HB400 - 12 mm	≥HB250 - 15 mm	S355 - 4 mm
	V-33	t 2,5 - 3,8	≥HB400 - 6 mm	S355 - Ø 70 mm	S355 - 5 mm	≥HB400 - 12 mm	≥HB250 - 20 mm	S355 - 5 mm
	V-38	t 3,8 - 5,8	≥HB400 - 6 mm	S355 - Ø 89 mm	S355 - 5 mm	≥HB400 - 15 mm	≥HB400 - 20 mm	S355 - 5 mm
	V-44	t 5,8 - 10	≥HB400 - 8 mm	S355 - Ø 102 mm	S355 - 8 mm	≥HB400 - 20 mm	≥HB400 - 25 mm	S355 - 8 mm
	V-49	t 10 - 12	≥HB400 - 10 mm	S355 - Ø 114 mm	S355 - 8 mm	≥HB400 - 20 mm	≥HB400 - 25 mm	S355 - 10 mm
	V-55	t 12 - 15	≥HB400 - 12 mm	S355 - Ø 114 mm	S355 - 8 mm	≥HB400 - 20 mm	≥HB400 - 32 mm	≥HB400 - 12 mm



BENNA RINFORZATA MAX LOCK
HEAVY DUTY BUCKET MAX LOCK
GODET RENFORCÉ MAX LOCK



V-20 t 1,4-1,8

Code	L mm	RL mm	P mm	ISO 7451 m ³	 n.	 kg	 ESTI E501	 FEURST FKM	 MTG MG5	 COMBI Mini T29	 ESCO V13 SYL
20QSCAR035	250	360	396	0,020	3	29	-	-	-	-	-
20QS3AR035	300	360	396	0,026	3	32	-	-	-	-	-
20QSDAR035	350	360	396	0,031	3	35	-	-	-	-	-
20QS4AR035	400	360	396	0,036	4	39	-	-	-	-	-
20QSEAR035	450	360	396	0,042	4	42	-	-	-	-	-
20QS5AR035	500	360	396	0,047	4	45	-	-	-	-	-
20QS6AR035	600	360	396	0,058	5	51	-	-	-	-	-

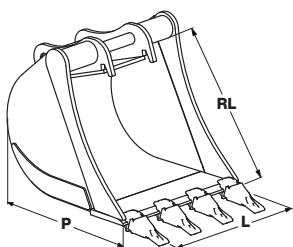









BENNA RINFORZATA MAX LOCK







HEAVY DUTY BUCKET MAX LOCK

GODET RENFORCÉ MAX LOCK

V-25 t 1,8-2,5

Code	L mm	RL mm	P mm	ISO 7451 m ³	 n.	 kg					
							ESTI E501	FEURST FKM	MTG MG5	COMBI Mini T29	ESCO V13 SYL
25QSCAR035	250	453	487	0,028	3	37	-	-	-	-	-
25QS3AR035	300	453	487	0,035	3	41	-	-	-	-	-
25QSDAR035	350	453	487	0,043	3	44	-	-	-	-	-
25QS4AR035	400	453	487	0,052	4	49	-	-	-	-	-
25QSEAR035	450	453	487	0,060	4	53	-	-	-	-	-
25QS5AR035	500	453	487	0,068	4	56	-	-	-	-	-
25QS6AR035	600	453	487	0,085	5	63	-	-	-	-	-
25QS7AR035	700	453	487	0,102	5	70	-	-	-	-	-

V-33 t 2,5-3,8

Code	L mm	RL mm	P mm	ISO 7451 m ³	 n.	 kg					
							ESTI E521	FEURST FK1	MTG MG8	COMBI Midi T29	ESCO V13 TYL
33QS3AR035	300	535	561	0,044	3	55	-	-	-	-	-
33QSDAR035	350	535	561	0,055	3	59	-	-	-	-	-
33QS4AR035	400	535	561	0,066	3	63	-	-	-	-	-
33QSEAR035	450	535	561	0,077	3	67	-	-	-	-	-
33QS5AR035	500	535	561	0,088	4	73	-	-	-	-	-
33QS6AR035	600	535	561	0,111	4	81	-	-	-	-	-
33QS7AR035	700	535	561	0,134	4	89	-	-	-	-	-
33QS8AR035	800	535	561	0,156	5	101	-	-	-	-	-

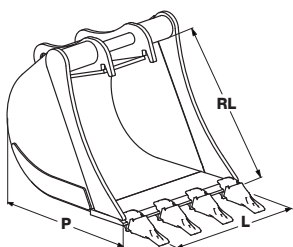









BENNA RINFORZATA MAX LOCK







HEAVY DUTY BUCKET MAX LOCK

GODET RENFORCÉ MAX LOCK

V-38 t 3,8-5,8

Code	L mm	RL mm	P mm	ISO 7451 m ³	 n.	 kg					
							ESTI E504	FEURST FK1	MTG MG8	COMBI Midi T29	ESCO V17 TYL
38QS3AR050	300	595	631	0,058	3	82	-	-	-	-	-
38QSDAR050	350	595	631	0,071	3	89	-	-	-	-	-
38QS4AR050	400	595	631	0,085	3	95	-	-	-	-	-
38QSEAR050	450	595	631	0,099	3	100	-	-	-	-	-
38QS5AR050	500	595	631	0,113	4	109	-	-	-	-	-
38QS6AR050	600	595	631	0,141	4	117	-	-	-	-	-
38QS7AR050	700	595	631	0,170	4	127	-	-	-	-	-
38QS8AR050	800	595	631	0,199	5	141	-	-	-	-	-
38QS9AR050	900	595	631	0,228	5	151	-	-	-	-	-

V-44 t 5,8-10

Code	L mm	RL mm	P mm	ISO 7451 m ³	 n.	 kg					
							CAT_STYLE J220	FEURST FK2	MTG MG10	COMBI CØ	ESCO U20
44QS3AR050	300	710	748	0,076	2	117	-	-	-	-	-
44QSDAR050	350	710	748	0,094	3	134	-	-	-	-	-
44QS4AR050	400	710	748	0,112	3	142	-	-	-	-	-
44QSEAR050	450	710	748	0,131	3	149	-	-	-	-	-
44QS5AR050	500	710	748	0,150	4	161	-	-	-	-	-
44QS6AR050	600	710	748	0,190	4	175	-	-	-	-	-
44QS7AR050	700	710	748	0,230	4	189	-	-	-	-	-
44QS8AR050	800	710	748	0,279	4	203	-	-	-	-	-
44QS9AR050	900	710	748	0,320	5	220	-	-	-	-	-
44QS1AR050	1000	710	748	0,360	5	235	-	-	-	-	-

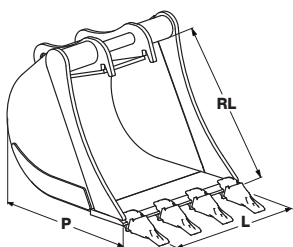



BENNA RINFORZATA MAX LOCK

HEAVY DUTY BUCKET MAX LOCK

GODET RENFORCÉ MAX LOCK

V-49 t 10-12

Code	L mm	RL mm	P mm	ISO 7451 m ³	n.	kg					
							CAT_SYSTEM J300	FEURST FK3	MTG MA15 - MG15	COMBI	ESCO U25
49QS4AR065	400	810	850	0,143	3	241	-	-	-	-	-
49QS5AR065	500	810	850	0,193	3	273	-	-	-	-	-
49QS6AR065	600	810	850	0,244	3	291	-	-	-	-	-
49QS7AR065	700	810	850	0,298	4	323	-	-	-	-	-
49QS8AR065	800	810	850	0,352	4	343	-	-	-	-	-
49QS9AR065	900	810	850	0,407	4	364	-	-	-	-	-
49QS1AR065	1000	810	850	0,462	5	397	-	-	-	-	-
49QSMAR065	1100	810	850	0,517	5	417	-	-	-	-	-
49QSNAR065	1200	810	850	0,572	5	438	-	-	-	-	-
49QSPAR065	1300	810	850	0,627	6	471	-	-	-	-	-

V-55 t 12-15

Code	L mm	RL mm	P mm	ISO 7451 m ³	n.	kg					
							CAT_SYSTEM J300	FEURST FK4	MTG MA15 - MG15	COMBI	ESCO U25
55QS4AR065	400	980	1027	0,194	3	308	-	-	-	-	-
55QS5AR065	500	980	1027	0,262	3	335	-	-	-	-	-
55QS6AR065	600	980	1027	0,352	3	377	-	-	-	-	-
55QS7AR065	700	980	1027	0,405	4	421	-	-	-	-	-
55QS8AR065	800	980	1027	0,487	4	451	-	-	-	-	-
55QS9AR065	900	980	1027	0,563	4	478	-	-	-	-	-
55QS1AR065	1000	980	1027	0,639	5	517	-	-	-	-	-
55QSMAR065	1100	980	1027	0,715	5	542	-	-	-	-	-
55QSNAR065	1200	980	1027	0,791	5	570	-	-	-	-	-
55QSPAR065	1300	980	1027	0,868	6	610	-	-	-	-	-
55QSQAR065	1400	980	1027	0,944	6	636	-	-	-	-	-

