

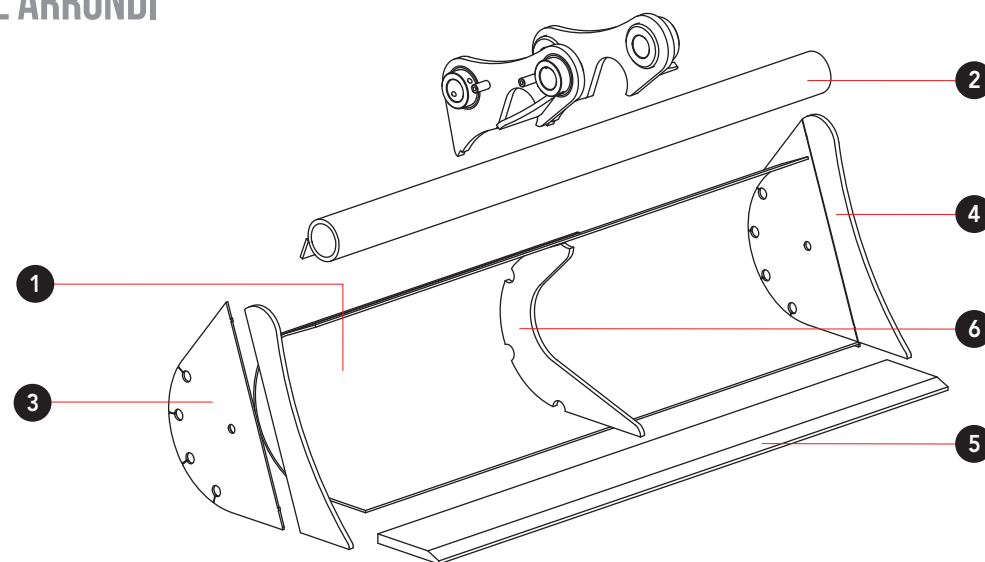

BENNA PULIZIA FOSSI PER MINIESCAVATORI - PROFILO ROTONDO
DITCH CLEANING BUCKET FOR MINIEXCAVATORS - ROUND PROFILE
GODET CURAGE POUR MINIPELLES - PROFIL ARRONDI





			1	2	3	4	5	6
Classe Class Classe	V-20	t 1,4 - 1,8	S355 - 4 mm	S355 - Ø 60 mm	S355 - 4 mm	S355 - 10 mm	≥HB250 - 15 mm	S355 - 8 mm
	V-25	t 1,8 - 2,5	S355 - 4 mm	S355 - Ø 70 mm	S355 - 4 mm	S355 - 10 mm	≥HB250 - 15 mm	S355 - 10 mm
	V-30	t 2,5 - 3,3	S355 - 4 mm	S355 - Ø 70 mm	S355 - 5 mm	S355 - 12 mm	≥HB250 - 15 mm	S355 - 12 mm
	V-35 / V-38	t 3,3 - 5,8	S355 - 6 mm	S355 - Ø 89 mm	S355 - 6 mm	S355 - 12 mm	≥HB250 - 15 mm	S355 - 12 mm
	V-45 / V-46	t 5,8 - 11	S355 - 6 mm	S355 - Ø 102 mm	S355 - 6 mm	S355 - 15 mm	≥HB250 - 20 mm	S355 - 12 mm





BENNA PULIZIA FOSSI PER MINIESCAVATORI - PROFILO ROTONDO
DITCH CLEANING BUCKET FOR MINIEXCAVATORS - ROUND PROFILE
GODET CURAGE POUR MINIPELLES - PROFIL ARRONDI



V-20 t 1,4-1,8

Code	L mm	RL mm	P mm	ISO 7451 m ³	 kg	€	Optionals 
20 - P8	800	342	345	0,067	45	-	-
20 - P1	1000	342	345	0,086	53	-	-

V-25 t 1,8-2,5

Code	L mm	RL mm	P mm	ISO 7451 m ³	 kg	€	Optionals 
25 - P1	1000	382	384	0,110	64	-	-
25 - PN	1200	382	384	0,134	70	-	-

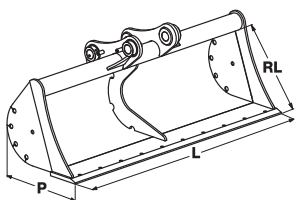





BENNA PULIZIA FOSSI PER MINIESCAVATORI - PROFILO ROTONDO



DITCH CLEANING BUCKET FOR MINIEXCAVATORS - ROUND PROFILE

GODET CURAGE POUR MINIPELLES - PROFIL ARRONDI



V-30 t 2,5-3,3

						Options	
Code	L mm	RL mm	P mm	ISO 7451 m ³	 kg	€	
30 - P1	1000	429	446	0,135	82	-	-
30 - PN	1200	429	446	0,165	95	-	-
30 - PQ	1400	429	446	0,195	105	-	-

V-35 / 38 t 3,3-5,8

						Options	
Code	L mm	RL mm	P mm	ISO 7451 m ³	 kg	€	
38 - PN	1200	460	484	0,200	124	-	-
38 - PQ	1400	460	484	0,236	138	-	-
38 - PR	1500	460	484	0,254	146	-	-
38 - PT	1600	460	484	0,272	155	-	-
38 - PA	1800	460	484	0,308	170	-	-

V-45 / 46 t 5,8-11

						Options	
Code	L mm	RL mm	P mm	ISO 7451 m ³	 kg	€	
45 - PN	1200	528	563	0,256	158	-	-
45 - PQ	1400	528	563	0,303	176	-	-
45 - PR	1500	528	563	0,326	185	-	-
45 - PT	1600	528	563	0,350	193	-	-
45 - PA	1800	528	563	0,397	211	-	-

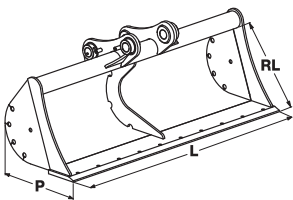



BENNA PULIZIA FOSSI PER MINIESCAVATORI - PROFILO SCANDINAVIA
DITCH CLEANING BUCKET FOR MINIEXCAVATORS - SCANDINAVIAN PROFILE
GODET CURAGE POUR MINIPELLE - PROFIL SCANDINAVE

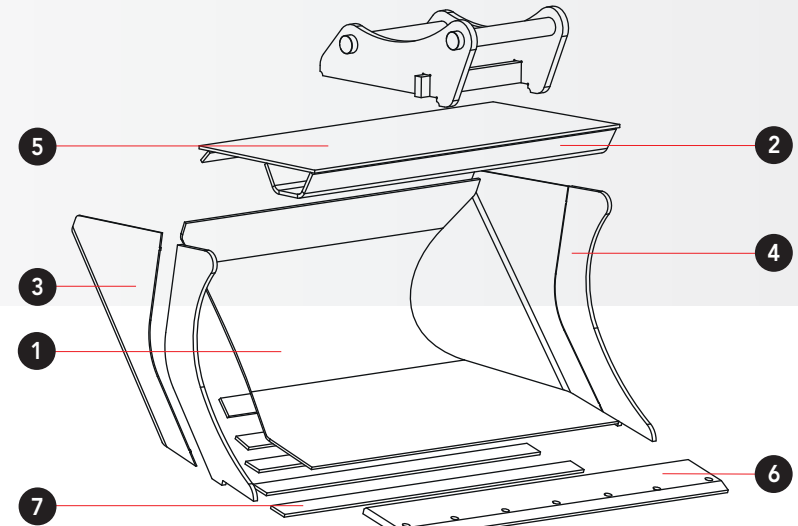
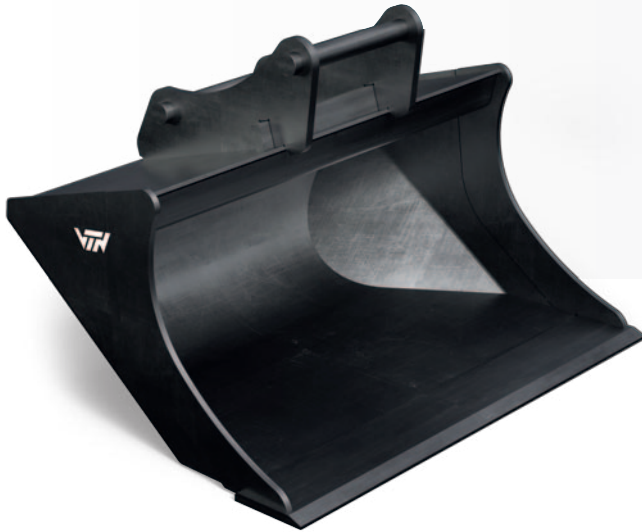

	Classe / Class Classe	1	2	3	4	5	6	7
V-45	t 5,8-8,5	HB400 - 8 mm	S355 - 12 mm	HB400 - 6 mm	HB400 - 12 mm	HB400 - 10 mm	HB500 - 20 mm	HB400 - 8 mm

V-45 t 5,8-8,5

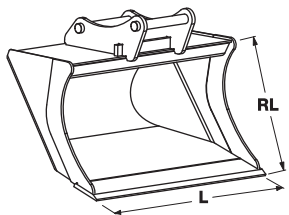

Code	L mm	RL mm	ISO 7451 m ³	kg	€	Optionals
45 - PDP	1300	700	350	240	-	 -