

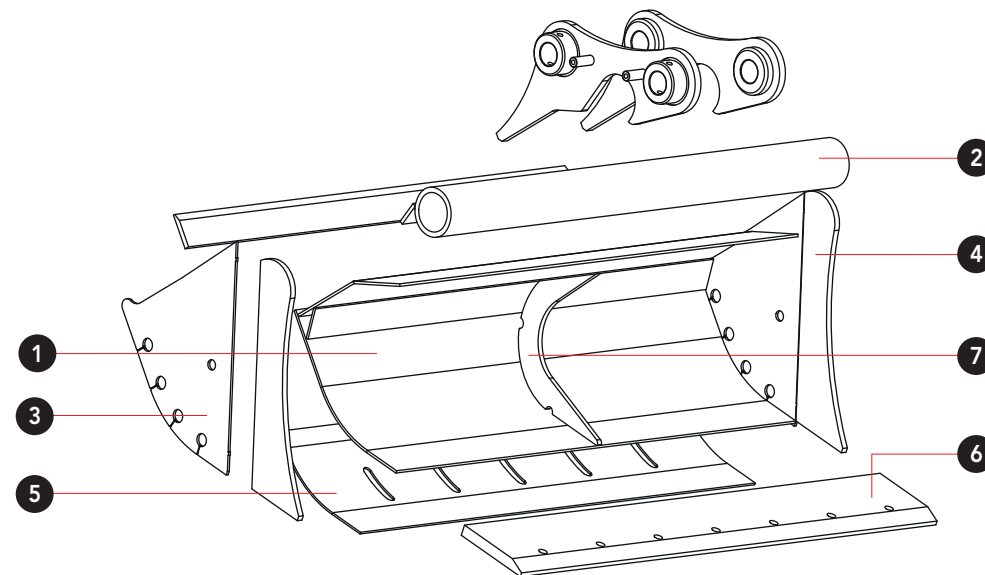

BENNA PULIZIA FOSSI - PROFILO ANGOLARE
DITCH CLEANING BUCKET - SQUARE PROFILE
GODET DE CURAGE - PROFIL PLAT





			1	2	3	4	5	6	7
Classe Class Classe	V-48	t 11 12 13	S355 - 6 mm	S355 - Ø 114 mm	S355 - 6 mm	S355 - 15 mm	S355 - 6 mm	≥HB400 - 20 mm	S355 - 15 mm
	V-55	t 12 15 16	S355 - 6 mm	S355 - Ø 114 mm	S355 - 6 mm	S355 - 15 mm	S355 - 6 mm	≥HB400 - 25 mm	S355 - 15 mm
	V-58	t 15 19 20	S355 - 6 mm	S355 - Ø 152 mm	S355 - 6 mm	S355 - 15 mm	S355 - 6 mm	≥HB400 - 25 mm	S355 - 15 mm
	V-63	t 19 23 25	S355 - 6 mm	S355 - Ø 152 mm	S355 - 8 mm	S355 - 20 mm	S355 - 6 mm	≥HB400 - 30 mm	S355 - 15 mm
	V-64	t 23 26 28	S355 - 6 mm	S355 - Ø 152 mm	S355 - 8 mm	S355 - 20 mm	S355 - 6 mm	≥HB400 - 32 mm	S355 - 15 mm
	V-68	t 26 31 33	S355 - 8 mm	S355 - Ø 178 mm	S355 - 10 mm	S355 - 25 mm	S355 - 8 mm	≥HB400 - 40 mm	S355 - 25 mm
	V-70	t 31 40 42	S355 - 10 mm	S355 - Ø 178 mm	S355 - 10 mm	S355 - 30 mm	S355 - 8 mm	≥HB400 - 40 mm	S355 - 25 mm

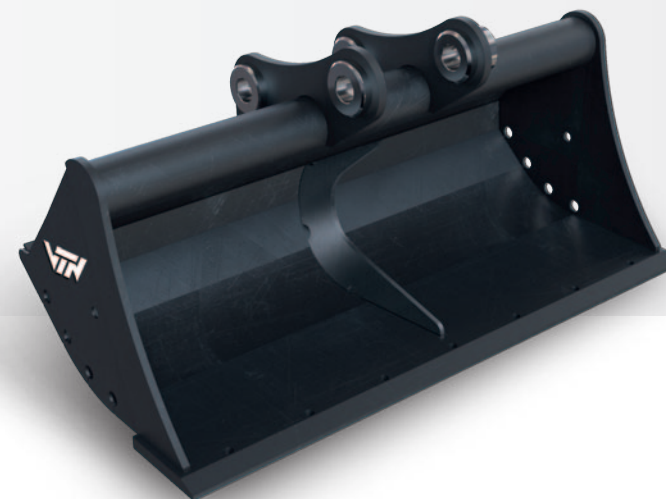

BENNA PULIZIA FOSSI - PROFILO ANGOLARE
DITCH CLEANING BUCKET - SQUARE PROFILE
GODET DE CURAGE - PROFIL PLAT



V-48 t 11 12 13

Code	L mm	RL mm	P mm	ISO 7451 m ³	 kg	€	Optionals	
							Code	
48-PQ-Z1	1400	576	740	0,362	285	-	PL14020RS20	-
48-PR-Z1	1500	576	740	0,390	300	-	PL15020RS20	-
48-PT-Z1	1600	576	740	0,419	315	-	PL16020RS20	-
48-PA-Z1	1800	576	740	0,476	346	-	PL18020RS201	-
48-PB-Z1	2000	576	740	0,533	376	-	PL20020RS20	-

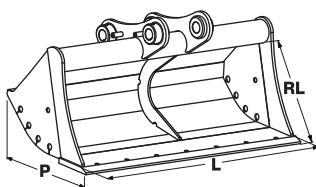



BENNA PULIZIA FOSSI - PROFILO ANGOLARE DITCH CLEANING BUCKET - SQUARE PROFILE GODET DE CURAGE - PROFIL PLAT

V-55 t 12 15 16

						Optionals		
Code	L mm	RL mm	P mm	ISO 7451 m ³	 kg	€	Code	
55-PR-Z1	1500	622	806	0,437	352	-	PL15025RS25	-
55-PA-Z1	1800	622	806	0,534	402	-	PL18025RS25	-
55-PB-Z1	2000	622	806	0,598	437	-	PL20025RS25	-
55-PJ-Z1	2200	622	806	0,662	472	-	PL22025RS251	-

V-58 t 15 19 20

						Optionals		
Code	L mm	RL mm	P mm	ISO 7451 m ³	 kg	€	Code	
58-PA-Z1	1800	687	890	0,683	476	-	PL18025RS25	-
58-PB-Z1	2000	687	890	0,766	516	-	PL20025RS25	-
58-PJ-Z1	2200	687	890	0,849	556	-	PL22025RS251	-
58-PW-Z1	2400	687	890	0,931	592	-	PL24025RS251	-
58-PK-Z1	2500	687	890	0,972	612	-	PL25025RS25	-

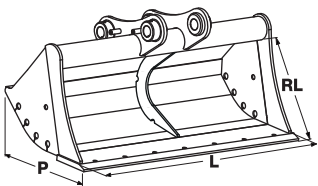



BENNA PULIZIA FOSSI - PROFILO ANGOLARE

DITCH CLEANING BUCKET - SQUARE PROFILE

GODET DE CURAGE - PROFIL PLAT

V-63 t 19 23 25

						Optionals		
Code	L mm	RL mm	P mm	ISO 7451 m ³	 kg	€	Code	
63-PA-Z1	1800	740	938	0,776	554	-	PL18025RS25	-
63-PB-Z1	2000	740	938	0,870	597	-	PL20025RS25	-
63-PJ-Z1	2200	740	938	0,963	640	-	PL22025RS251	-
63-PW-Z1	2400	740	938	1,057	683	-	PL24025RS251	-
63-PK-Z1	2500	740	938	1,104	705	-	PL25025RS25	-

V-64 t 23 26 28

						Optionals		
Code	L mm	RL mm	P mm	ISO 7451 m ³	 kg	€	Code	
64 - PA-Z1	1800	808	1019	0,896	591	-	PL18025RS25	-
64 - PB-Z1	2000	808	1019	1,006	637	-	PL20025RS25	-
64 - PJ-Z1	2200	808	1019	1,116	683	-	PL22025RS251	-
64 - PW-Z1	2400	808	1019	1,226	729	-	PL24025RS251	-
64 - PK-Z1	2500	808	1019	1,281	753	-	PL25025RS25	-

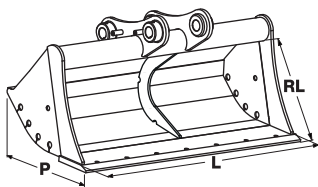



BENNA PULIZIA FOSSI - PROFILO ANGOLARE DITCH CLEANING BUCKET - SQUARE PROFILE GODET DE CURAGE - PROFIL PLAT

V-68 t 26 31 33

						Optionals		
Code	L mm	RL mm	P mm	ISO 7451 m ³	 kg	€	Code	
68 - PA-Z1	1800	931	1055	1,186	874	-	PL18033RS25	-
68 - PB-Z1	2000	931	1055	1,335	944	-	PL20033RS25	-
68 - PJ-Z1	2200	931	1055	1,485	1049	-	PL22033RS25	-
68 - PW-Z1	2400	931	1055	1,633	1119	-	PL24033RS251	-
68 - PK-Z1	2500	931	1055	1,708	1155	-	PL25033RS25	-

V-70 t 31 40 42

						Optionals		
Code	L mm	RL mm	P mm	ISO 7451 m ³	 kg	€	Code	
70 - PA-Z1	1800	996	1223	1,340	969	-	PL18033RS25	-
70 - PB-Z1	2000	996	1223	1,508	1047	-	PL20033RS25	-
70 - PJ-Z1	2200	996	1223	1,676	1173	-	PL22033RS25	-
70 - PW-Z1	2400	996	1223	1,844	1251	-	PL24033RS251	-
70 - PK-Z1	2500	996	1223	1,929	1291	-	PL25033RS25	-

