

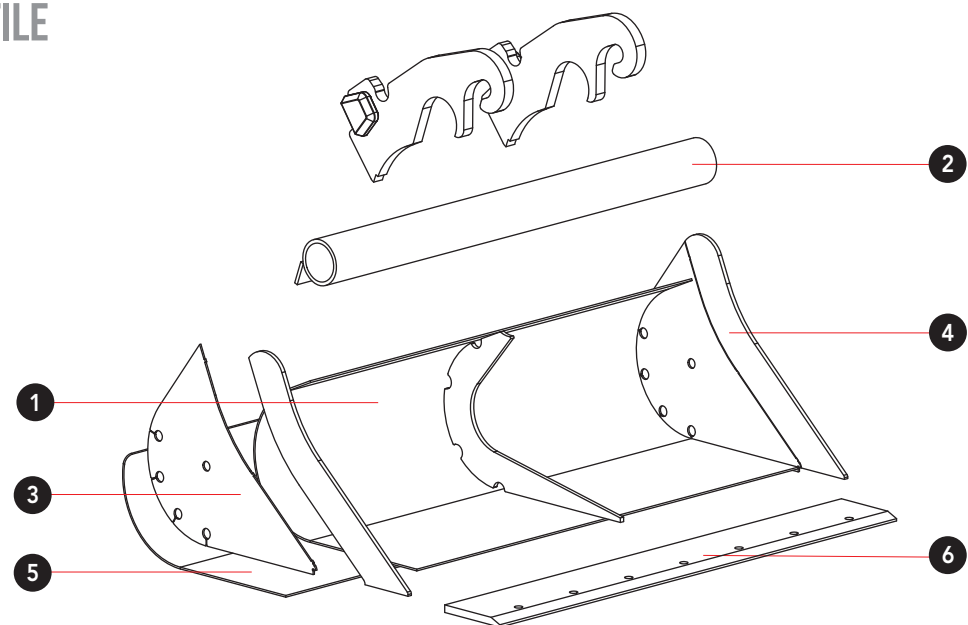

BENNA PULIZIA FOSSI - PROFILO OLANDA
DITCH CLEANING BUCKET - HOLLAND PROFILE
GODET DE CURAGE - PROFIL OLANDA



		1	2	3	4	5	6	7	
Classe Class Classe	V-48	t 11-12-13	S355 - 6 mm	S355 - Ø 114 mm	S355 - 6 mm	S355 - 15 mm	S355 - 5 mm	≥HB400 - 20 mm	S355 - 15 mm
	V-55	t 12-15-16	S355 - 6 mm	S355 - Ø 114 mm	S355 - 6 mm	S355 - 15 mm	S355 - 6 mm	≥HB400 - 25 mm	S355 - 15 mm
	V-58	t 15-19-20	S355 - 6 mm	S355 - Ø 152 mm	S355 - 6 mm	S355 - 15 mm	S355 - 6 mm	≥HB400 - 25 mm	S355 - 15 mm
	V-63	t 19-23-25	S355 - 6 mm	S355 - Ø 152 mm	S355 - 8 mm	S355 - 20 mm	S355 - 6 mm	≥HB400 - 32 mm	S355 - 15 mm
	V-64	t 23-26-28	S355 - 6 mm	S355 - Ø 152 mm	S355 - 8 mm	S355 - 20 mm	S355 - 6 mm	≥HB400 - 32 mm	S355 - 15 mm
	V-68	t 26-31-33	S355 - 8 mm	S355 - Ø 178 mm	S355 - 10 mm	S355 - 25 mm	S355 - 8 mm	≥HB400 - 40 mm	S355 - 25 mm
	V-70	t 31-40-42	S355 - 10 mm	S355 - Ø 178 mm	S355 - 10 mm	S355 - 30 mm	S355 - 8 mm	≥HB400 - 40 mm	S355 - 25 mm



BENNA PULIZIA FOSSI - PROFILO OLANDA
DITCH CLEANING BUCKET - HOLLAND PROFILE
GODET DE CURAGE - PROFIL OLANDA



V-48 t 11 12 13

Code	L mm	RL mm	P mm	ISO 7451 m ³	kg	€	Optionals	
							Code	
48 - HQ	1400	721	834	0,483	291	-	PL14020RS20	-
48 - HR	1500	721	834	0,522	305	-	PL15020RS20	-
48 - HT	1600	721	834	0,560	321	-	PL16020RS20	-
48 - HA	1800	721	834	0,638	351	-	PL18020RS201	-
48 - HB	2000	721	834	0,715	384	-	PL20020RS20	-

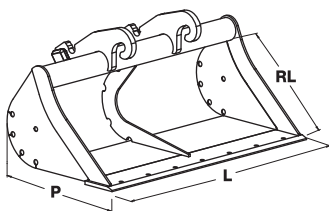





BENNA PULIZIA FOSSI - PROFILO OLANDA

DITCH CLEANING BUCKET - HOLLAND PROFILE

GODET DE CURAGE - PROFIL OLANDA

V-55 t 12 15 16

						Optionals		
Code	L mm	RL mm	P mm	ISO 7451 m ³	 kg	€	Code	
55 - HR	1500	780	903	0,582	366	-	PL15025RS25	-
55 - HA	1800	780	903	0,712	421	-	PL18025RS25	-
55 - HB	2000	780	903	0,798	457	-	PL20025RS25	-
55 - HJ	2200	780	903	0,885	494	-	PL22025RS251	-

V-58 t 15 19 20

						Optionals		
Code	L mm	RL mm	P mm	ISO 7451 m ³	 kg	€	Code	
58 - HA	1800	856	1000	0,910	497	-	PL18025RS25	-
58 - HB	2000	856	1000	1,020	540	-	PL20025RS25	-
58 - HJ	2200	856	1000	1,132	583	-	PL22025RS251	-
58 - HW	2400	856	1000	1,242	624	-	PL24025RS251	-
58 - HK	2500	856	1000	1,300	645	-	PL25025RS25	-

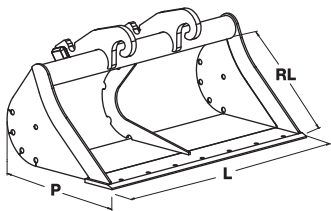



BENNA PULIZIA FOSSI - PROFILO OLANDA

DITCH CLEANING BUCKET - HOLLAND PROFILE

GODET DE CURAGE - PROFIL OLANDA

V-63 t 19 23 25

Code	L mm	RL mm	P mm	ISO 7451 m ³	 kg	€	Optionals	
							Code	
63 - HA	1800	936	1083	1,041	583	-	PL18025RS25	-
63 - HB	2000	936	1083	1,171	629	-	PL20025RS25	-
63 - HJ	2200	936	1083	1,302	677	-	PL22025RS251	-
63 - HW	2400	936	1083	1,432	723	-	PL24025RS251	-
63 - HK	2500	936	1083	1,497	746	-	PL25025RS25	-

V-64 t 23 26 28

Code	L mm	RL mm	P mm	ISO 7451 m ³	 kg	€	Optionals	
							Code	
64 - HA	1800	1001	1150	1,181	627	-	PL18025RS25	-
64 - HB	2000	1001	1150	1,330	676	-	PL20025RS25	-
64 - HJ	2200	1001	1150	1,479	726	-	PL22025RS251	-
64 - HW	2400	1001	1150	1,628	775	-	PL24025RS251	-
64 - HK	2500	1001	1150	1,702	800	-	PL25025RS25	-

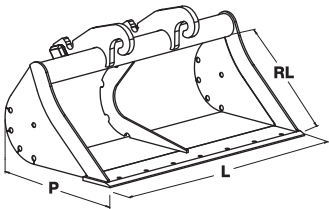



BENNA PULIZIA FOSSI - PROFILO OLANDA

DITCH CLEANING BUCKET - HOLLAND PROFILE

GODET DE CURAGE - PROFIL OLANDA

V-68 t 26 31 33

						Optionals		
Code	L mm	RL mm	P mm	ISO 7451 m ³	 kg	€	Code	
68 - HA	1800	1195	1374	1,626	971	-	PL18033RS25	-
68 - HB	2000	1195	1374	1,837	1050	-	PL20033RS25	-
68 - HJ	2200	1195	1374	2,048	1128	-	PL22033RS25	-
68 - HW	2400	1195	1374	2,259	1207	-	PL24033RS251	-
68 - HK	2500	1195	1374	2,365	1245	-	PL25033RS25	-

V-70 t 31 40 42

						Optionals		
Code	L mm	RL mm	P mm	ISO 7451 m ³	 kg	€	Code	
70 - HA	1800	1270	1460	1,822	1054	-	PL18033RS25	-
70 - HB	2000	1270	1460	2,062	1139	-	PL20033RS25	-
70 - HJ	2200	1270	1460	2,300	1224	-	PL22033RS25	-
70 - HW	2400	1270	1460	2,540	1309	-	PL24033RS251	-
70 - HK	2500	1270	1460	2,660	1351	-	PL25033RS25	-

