

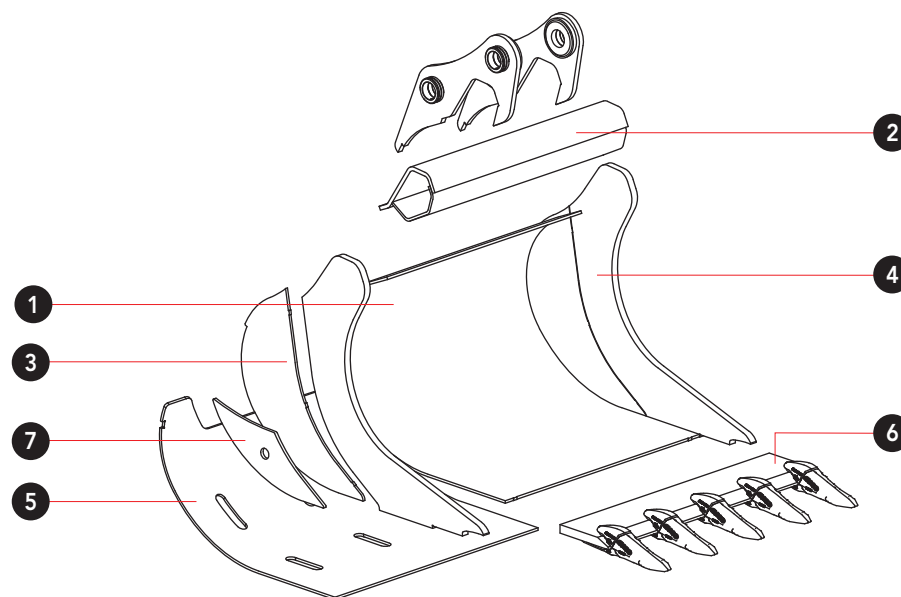

BENNA SEMI-MASSO

SEMI-STONE BUCKET

GODET DEMI BLOC



Le benne di classe superiore a V-70 sono prodotte su misura e richiesta.
 Buckets class upper than V-70 are tailor-made on demand.
 Les godets d'une classe supérieure à V-70 sont produits sur mesure et sur demande.







			1	2	3	4	5	6	7
Classe Class Classe	V-55	t 12 15 16	S355 - 10 mm	S355 - 12 mm	S355 - 10 mm	≥HB400 - 20 mm	≥HB400 - 8 mm	≥HB400 - 32 mm	≥HB400 - 10 mm
	V-58	t 15 19 20	S355 - 10 mm	S355 - 18 mm	S355 - 10 mm	≥HB400 - 25 mm	≥HB400 - 10 mm	≥HB400 - 35 mm	≥HB400 - 12 mm
	V-63 / V-64	t 19 26 28	S355 - 12 mm	S355 - 18 mm	S355 - 12 mm	≥HB400 - 30 mm	≥HB400 - 12 mm	≥HB400 - 40 mm	≥HB400 - 15 mm
	V-68 / V-70	t 26 40 42	S355 - 15 mm	S355 - 20 mm	S355 - 12 mm	≥HB400 - 35 mm	≥HB400 - 12 mm	≥HB400 - 50 mm	≥HB400 - 20 mm



BENNA SEMI-MASSO SEMI-STONE BUCKET GODET DEMI BLOC



V-55 t 12 15 16

Code	L mm	RL mm	P mm	ISO 7451 m ³	 n.	 kg	 CAT_STYLE J300	 FEURST FK5	 MTG MA20	 Combi R14	 ESCO U30
55 - Y5	500	1000	1102	0,197	3	345	-	-	-	-	-
55 - Y6	600	1000	1102	0,253	3	375	-	-	-	-	-
55 - Y8	800	1000	1102	0,382	4	468	-	-	-	-	-
55 - Y1	1000	1000	1102	0,506	5	542	-	-	-	-	-
55 - YM	1100	1000	1102	0,570	5	570	-	-	-	-	-
55 - YN	1200	1000	1102	0,632	5	605	-	-	-	-	-

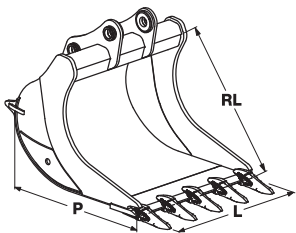









BENNA SEMI-MASSO







SEMI-STONE BUCKET

GODET DEMI BLOC







V-58 t 15 19 20

Code	L mm	RL mm	P mm	ISO 7451 m ³	 n.	 kg	 CAT_STYLE	 FEURST	 MTG	 Combi	 ESCO
							J350	FK5	MA30	R18	U35
58 - Y5	500	1167	1332	0,276	3	514	-	-	-	-	-
58 - Y6	600	1167	1332	0,355	3	556	-	-	-	-	-
58 - Y8	800	1167	1332	0,534	4	666	-	-	-	-	-
58 - Y1	1000	1167	1332	0,710	4	753	-	-	-	-	-
58 - YM	1100	1167	1332	0,800	5	814	-	-	-	-	-
58 - YN	1200	1167	1332	0,890	5	856	-	-	-	-	-

V-63 / V-64 t 19 26 28

Code	L mm	RL mm	P mm	ISO 7451 m ³	 n.	 kg	 CAT_STYLE	 FEURST	 MTG	 Combi	 ESCO
							J400	FK7	MA40	R23	U40
63 - Y6	600	1220	1400	0,400	3	716	-	-	-	-	-
63 - Y8	800	1220	1400	0,597	4	860	-	-	-	-	-
63 - Y1	1000	1220	1400	0,800	4	967	-	-	-	-	-
63 - YN	1200	1220	1400	1,008	5	1098	-	-	-	-	-
63 - YP	1300	1220	1400	1,115	5	1149	-	-	-	-	-

V-68 / V-70 t 26 40 42

Code	L mm	RL mm	P mm	ISO 7451 m ³	 n.	 kg	 CAT_STYLE	 FEURST	 MTG	 Combi	 ESCO
							J460	FK9	MA50	R29	U45
68 - Y1	1000	1372	1650	1,015	4	1436	-	-	-	-	-
68 - YN	1200	1372	1650	1,286	4	1604	-	-	-	-	-
68 - YP	1300	1372	1650	1,424	5	1713	-	-	-	-	-
68 - YQ	1400	1372	1650	1,563	5	1786	-	-	-	-	-
68 - YR	1500	1372	1650	1,704	5	1861	-	-	-	-	-
68 - YT	1600	1372	1650	1,844	5	1936	-	-	-	-	-

