

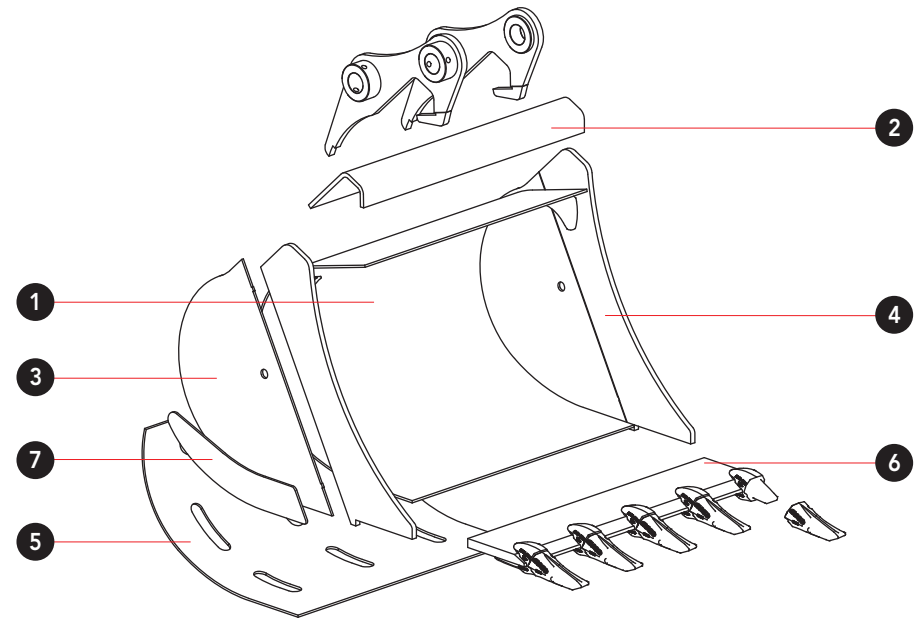

BENNA RINFORZATA - HD

HEAVY DUTY BUCKET - HD

GODET RENFORCÉ - HD



Le benne di classe superiore a V-73 sono prodotte su misura e richiesta.
 Buckets class upper than V-73 are tailor-made on demand.
 Les godets d'une classe supérieure à V-73 sont produits sur mesure et sur demande.







		1	2	3	4	5	6	7	
Classe Class Classe	V-47	t 10 - 11 - 12	S355 - 8 mm	S355 - 15 mm	S355 - 8 mm	≥HB400 - 20 mm	≥HB400 - 8 mm	≥HB400 - 25 mm	S355 - 10 mm
	V-48	t 11 - 12 - 13	S355 - 8 mm	S355 - 15 mm	S355 - 8 mm	≥HB400 - 20 mm	≥HB400 - 8 mm	≥HB400 - 25 mm	S355 - 12 mm
	V-55	t 12 - 15 - 16	S355 - 8 mm	S355 - 12 mm	S355 - 8 mm	≥HB400 - 20 mm	≥HB400 - 8 mm	≥HB400 - 32 mm	≥HB400 - 12 mm
	V-58	t 15 - 19 - 20	S355 - 8 mm	S355 - 18 mm	S355 - 8 mm	≥HB400 - 25 mm	≥HB400 - 10 mm	≥HB400 - 35 mm	≥HB400 - 12 mm
	V-63	t 19 - 23 - 25	S355 - 10 mm	S355 - 18 mm	S355 - 8 mm	≥HB400 - 25 mm	≥HB400 - 10 mm	≥HB400 - 40 mm	≥HB400 - 12 mm
	V-64	t 23 - 26 - 28	S355 - 10 mm	S355 - 18 mm	S355 - 10 mm	≥HB400 - 30 mm	≥HB400 - 10 mm	≥HB400 - 40 mm	≥HB400 - 12 mm
	V-68	t 26 - 31 - 33	S355 - 12 mm	S355 - 20 mm	S355 - 10 mm	≥HB400 - 35 mm	≥HB400 - 10 mm	≥HB400 - 45 mm	≥HB400 - 15 mm
	V-70	t 31 - 40 - 42	S355 - 15 mm	S355 - 20 mm	S355 - 12 mm	≥HB400 - 35 mm	≥HB400 - 12 mm	≥HB400 - 45 mm	≥HB400 - 15 mm
	V-73	t 40 - 50 - 52	S355 - 15 mm	S355 - 20 mm	S355 - 12 mm	≥HB400 - 40 mm	≥HB400 - 12 mm	≥HB400 - 50 mm	≥HB400 - 15 mm



BENNA RINFORZATA - HD
HEAVY DUTY BUCKET - HD
GODET RENFORCÉ - HD



V-47 t 10-11-12

Code	L mm	RL mm	P mm	ISO 7451 m ³	n. 	kg 					
							CAT_STYLE J220	FEURST FK3	MTG MG10	COMBI C1	ESCO U20
47 - F3	300	789	880	0,095	2	198	-	-	-	-	-
47 - FD	350	789	880	0,118	3	215	-	-	-	-	-
47 - F4	400	789	880	0,142	3	227	-	-	-	-	-
47 - FE	450	789	880	0,167	3	239	-	-	-	-	-
47 - F5	500	789	880	0,191	3	251	-	-	-	-	-
47 - F6	600	789	880	0,243	4	280	-	-	-	-	-
47 - F7	700	789	880	0,299	4	307	-	-	-	-	-
47 - F8	800	789	880	0,352	4	336	-	-	-	-	-
47 - F9	900	789	880	0,406	5	363	-	-	-	-	-
47 - F1	1000	789	880	0,460	5	387	-	-	-	-	-
47 - FN	1200	789	880	0,567	5	434	-	-	-	-	-

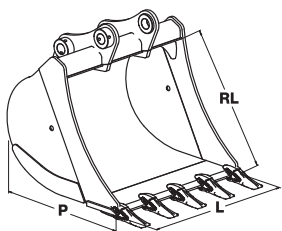



BENNA RINFORZATA - HD / HEAVY DUTY BUCKET - HD / GODET RENFORCÉ - HD

V-48 t 11 12 13

Code	L mm	RL mm	P mm	ISO 7451 m ³	n.	kg					
							CAT_STYLE J300	FEURST FK3	MTG MG15 - MA15	COMBI R10	ESCO U25
48 - F4	400	834	906	0,152	3	268	-	-	-	-	-
48 - F5	500	834	906	0,205	3	292	-	-	-	-	-
48 - F6	600	834	906	0,260	3	316	-	-	-	-	-
48 - F7	700	834	906	0,317	4	353	-	-	-	-	-
48 - F8	800	834	906	0,379	4	386	-	-	-	-	-
48 - F9	900	834	906	0,438	4	410	-	-	-	-	-
48 - F1	1000	834	906	0,496	5	446	-	-	-	-	-
48 - FN	1200	834	906	0,613	5	494	-	-	-	-	-
48 - FP	1300	834	906	0,671	6	530	-	-	-	-	-

V-55 t 12 15 16

Code	L mm	RL mm	P mm	ISO 7451 m ³	n.	kg					
							CAT_STYLE J300	FEURST FK4	MTG MG15 - MA15	COMBI R10	ESCO U25
55 - F4	400	964	1027	0,194	3	323	-	-	-	-	-
55 - F5	500	964	1027	0,262	3	351	-	-	-	-	-
55 - F6	600	964	1027	0,332	3	379	-	-	-	-	-
55 - F7	700	964	1027	0,409	4	424	-	-	-	-	-
55 - F8	800	964	1027	0,487	4	460	-	-	-	-	-
55 - F9	900	964	1027	0,563	4	490	-	-	-	-	-
55 - F1	1000	964	1027	0,639	5	531	-	-	-	-	-
55 - FM	1100	964	1027	0,715	5	558	-	-	-	-	-
55 - FN	1200	964	1027	0,791	5	586	-	-	-	-	-
55 - FP	1300	964	1027	0,868	6	627	-	-	-	-	-
55 - FQ	1400	964	1027	0,944	6	655	-	-	-	-	-

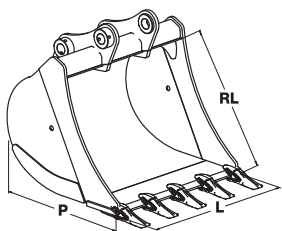



BENNA RINFORZATA - HD / HEAVY DUTY BUCKET - HD / GODET RENFORCÉ - HD

V-58 t 15 19 20

Code	L mm	RL mm	P mm	ISO 7451 m ³	n.	kg					
							CAT_STYLE J350	FEURST FK5	MTG MG20 - MA20	COMBI R14	ESCO U30
58 - F4	400	1043	1122	0,212	2	398	-	-	-	-	-
58 - F5	500	1043	1122	0,290	3	453	-	-	-	-	-
58 - F6	600	1043	1122	0,373	3	490	-	-	-	-	-
58 - F7	700	1043	1122	0,460	3	527	-	-	-	-	-
58 - F8	800	1043	1122	0,560	4	589	-	-	-	-	-
58 - F9	900	1043	1122	0,649	4	630	-	-	-	-	-
58 - F1	1000	1043	1122	0,738	4	666	-	-	-	-	-
58 - FM	1100	1043	1122	0,828	5	720	-	-	-	-	-
58 - FN	1200	1043	1122	0,918	5	755	-	-	-	-	-
58 - FP	1300	1043	1122	1,008	5	793	-	-	-	-	-
58 - FQ	1400	1043	1122	1,100	5	828	-	-	-	-	-

V-63 t 19 23 25

Code	L mm	RL mm	P mm	ISO 7451 m ³	n.	kg					
							CAT_STYLE J350	FEURST FK7	MTG MG30 - MA30	COMBI R18	ESCO U35
63 - F5	500	1090	1263	0,355	3	521	-	-	-	-	-
63 - F6	600	1090	1263	0,452	3	565	-	-	-	-	-
63 - F7	700	1090	1263	0,553	3	608	-	-	-	-	-
63 - F8	800	1090	1263	0,650	4	676	-	-	-	-	-
63 - F9	900	1090	1263	0,753	4	723	-	-	-	-	-
63 - F1	1000	1090	1263	0,857	4	767	-	-	-	-	-
63 - FN	1200	1090	1263	1,068	5	872	-	-	-	-	-
63 - FP	1300	1090	1263	1,174	5	916	-	-	-	-	-
63 - FQ	1400	1090	1263	1,280	5	957	-	-	-	-	-
63 - FR	1500	1090	1263	1,386	6	1019	-	-	-	-	-
63 - FT	1600	1090	1263	1,493	6	1067	-	-	-	-	-

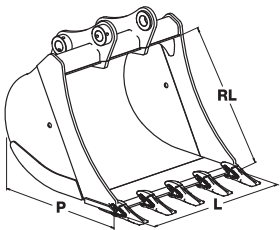



BENNA RINFORZATA - HD / HEAVY DUTY BUCKET - HD / GODET RENFORCÉ - HD

V-64 t 23 26 28

Code	L mm	RL mm	P mm	ISO 7451 m ³	n.	kg					
							CAT_STYLE J350	FEURST FK7	MTG MG30 - MA30	COMBI R18	ESCO U35
64 - F5	500	1169	1322	0,370	3	582	-	-	-	-	-
64 - F6	600	1169	1322	0,475	3	628	-	-	-	-	-
64 - F7	700	1169	1322	0,584	3	674	-	-	-	-	-
64 - F8	800	1169	1322	0,727	4	750	-	-	-	-	-
64 - F9	900	1169	1322	0,841	4	797	-	-	-	-	-
64 - F1	1000	1169	1322	0,958	4	845	-	-	-	-	-
64 - FN	1200	1169	1322	1,195	5	952	-	-	-	-	-
64 - FP	1300	1169	1322	1,314	5	998	-	-	-	-	-
64 - FQ	1400	1169	1322	1,433	5	1041	-	-	-	-	-
64 - FR	1500	1169	1322	1,533	6	1087	-	-	-	-	-
64 - FT	1600	1169	1322	1,672	6	1150	-	-	-	-	-

V-68 t 26 31 33



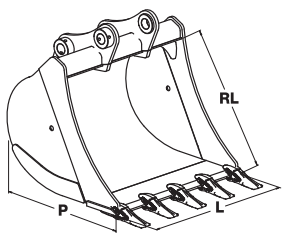



Code	L mm	RL mm	P mm	ISO 7451 m ³	n.	kg					
							CAT_STYLE J400	FEURST FK9	MTG MG40 - MA40	COMBI R23	ESCO U40
68 - F5	500	1249	1487	0,402	3	846	-	-	-	-	-
68 - F6	600	1249	1487	0,519	3	909	-	-	-	-	-
68 - F7	700	1249	1487	0,640	3	972	-	-	-	-	-
68 - F8	800	1249	1487	0,780	4	1070	-	-	-	-	-
68 - F9	900	1249	1487	0,908	4	1132	-	-	-	-	-
68 - F1	1000	1249	1487	1,040	4	1196	-	-	-	-	-
68 - FN	1200	1249	1487	1,310	5	1356	-	-	-	-	-
68 - FP	1300	1249	1487	1,445	5	1418	-	-	-	-	-
68 - FQ	1400	1249	1487	1,580	5	1480	-	-	-	-	-
68 - FR	1500	1249	1487	1,718	5	1542	-	-	-	-	-
68 - FT	1600	1249	1487	1,857	5	1606	-	-	-	-	-
68 - FU	1700	1249	1487	1,995	6	1694	-	-	-	-	-











BENNA RINFORZATA - HD / HEAVY DUTY BUCKET - HD / GODET RENFORCÉ - HD

V-70 t 31-40-42

Code	L mm	RL mm	P mm	ISO 7451 m ³	 n.	 kg	 CAT_STYLE	 FEURST	 MTG	 COMBI	 ESCO
							J460	FK9	MG55 - MA50	R29	U45
70 - F6	600	1348	1572	0,585	3	1070	-	-	-	-	-
70 - F7	700	1348	1572	0,722	3	1143	-	-	-	-	-
70 - F8	800	1348	1572	0,878	4	1262	-	-	-	-	-
70 - F9	900	1348	1572	1,023	4	1334	-	-	-	-	-
70 - F1	1000	1348	1572	1,172	4	1408	-	-	-	-	-
70 - FN	1200	1348	1572	1,475	4	1559	-	-	-	-	-
70 - FP	1300	1348	1572	1,630	5	1667	-	-	-	-	-
70 - FQ	1400	1348	1572	1,786	5	1737	-	-	-	-	-
70 - FR	1500	1348	1572	1,943	5	1809	-	-	-	-	-
70 - FT	1600	1348	1572	2,100	5	1882	-	-	-	-	-
70 - FA	1800	1348	1572	2,415	6	2054	-	-	-	-	-

V-73 t 40-50-52

Code	L mm	RL mm	P mm	ISO 7451 m ³	 n.	 kg	 CAT_STYLE	 FEURST	 MTG	 COMBI	 ESCO
							J550	FK11	MG65 - MA60	R29	U55
73 - F7	700	1463	1693	0,860	2	1364	-	-	-	-	-
73 - F8	800	1463	1693	1,050	3	1513	-	-	-	-	-
73 - F9	900	1463	1693	1,222	3	1591	-	-	-	-	-
73 - F1	1000	1463	1693	1,400	3	1670	-	-	-	-	-
73 - FN	1200	1463	1693	1,765	4	1890	-	-	-	-	-
73 - FP	1300	1463	1693	1,950	4	1969	-	-	-	-	-
73 - FQ	1400	1463	1693	2,136	4	2046	-	-	-	-	-
73 - FR	1500	1463	1693	2,325	5	2179	-	-	-	-	-
73 - FT	1600	1463	1693	2,516	5	2258	-	-	-	-	-
73 - FA	1800	1463	1693	2,900	6	2414	-	-	-	-	-

